

LEKI TO NIE CVKIERKI!

BAW SIĘ I KOŁORUJ Z MISIEM LEKUSIEM

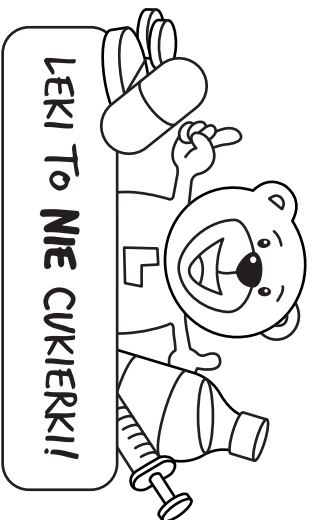

POMÓŻ LEKUSIOWI
ZNALEZĆ DROGĘ
DO APTEKI

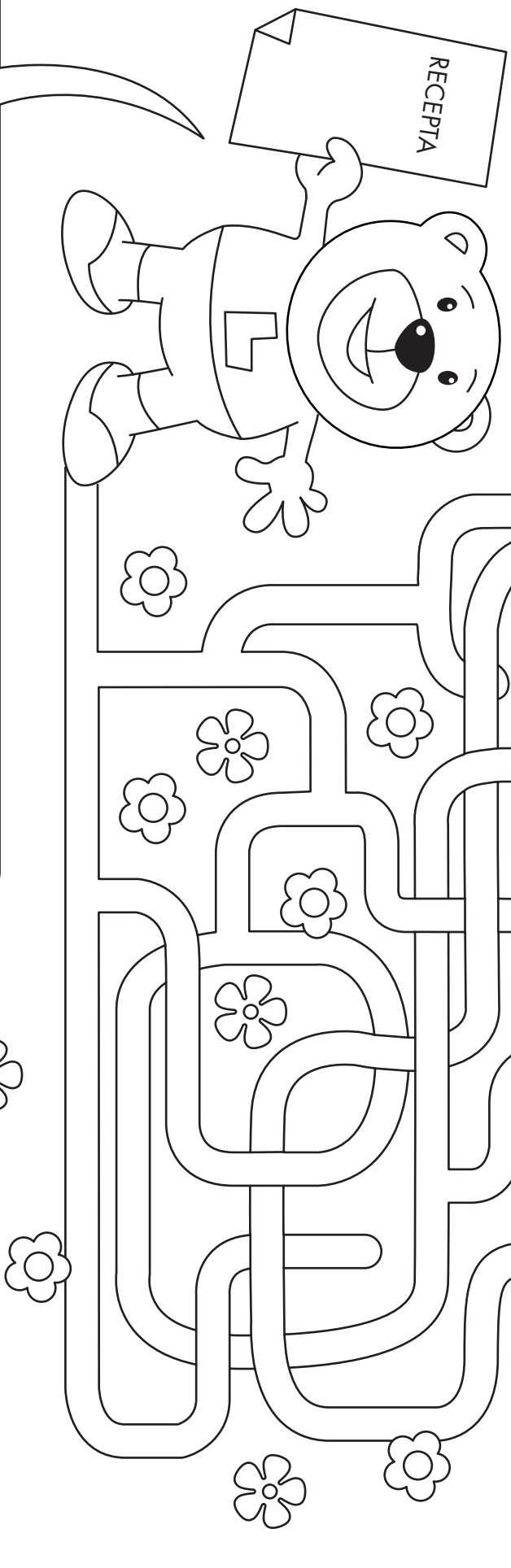

MIŚ LEKUŚ PRZYPOMINA: LEKI KUPUJ W APTECE!

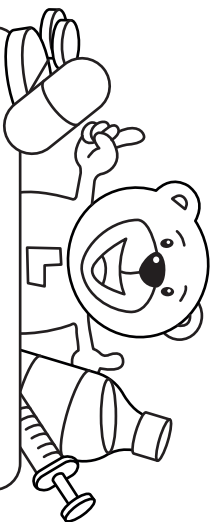

LEKI TO NIE CUKIERKI!

POMÓŻ LEKUSIOWI
DOPASOWAĆ PODPIS
DO ODPOWIEDNIEJ POSTACI LEKU

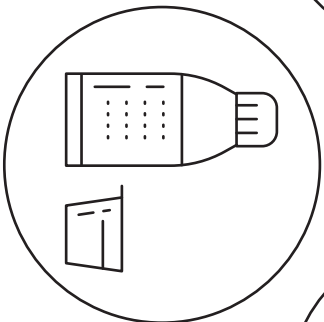
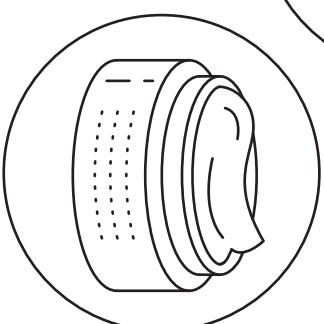
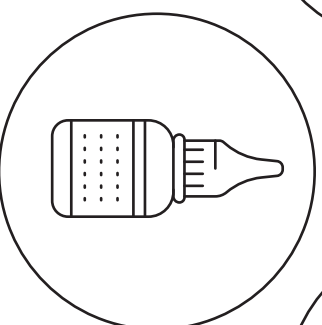
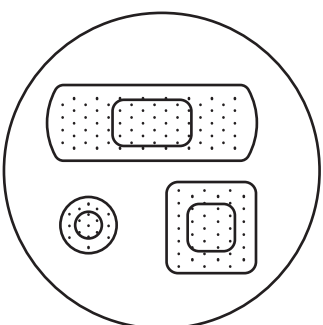
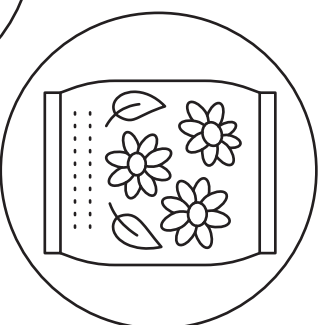
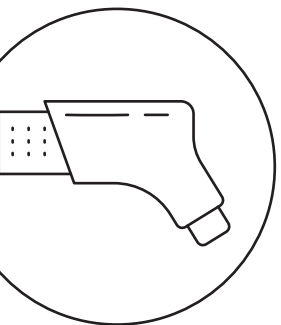
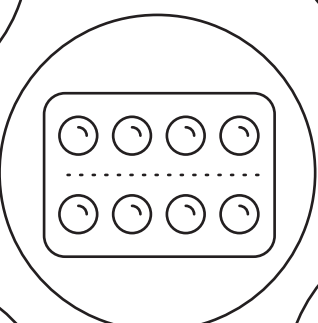
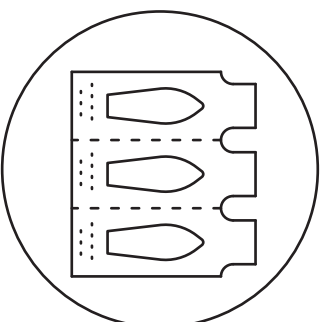
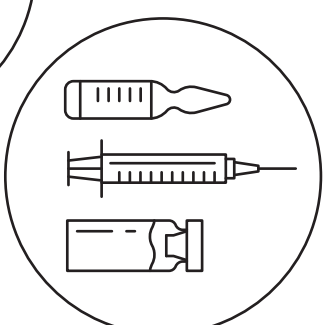
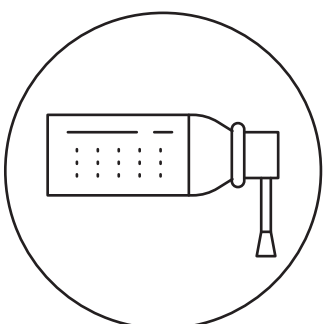
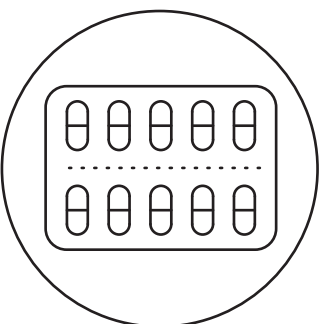

krem

tabletki

inhalator

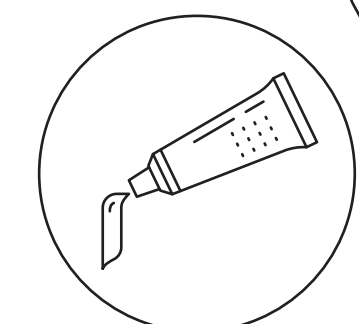

krople

czopki

kapsułki

maść

zastrzyki

plastry

syrop

leki roślinne

spray

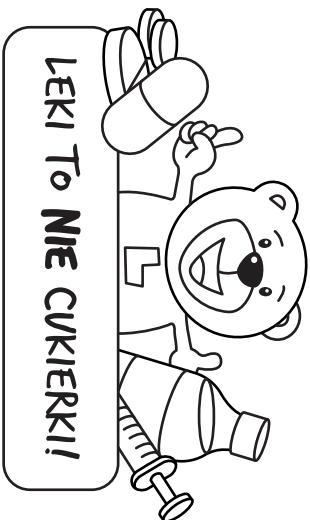

SAMODZIELNIE
ZAPROJEKTUJ WZÓR
NA ULUBIONYM
KUBE CZKU LEKUSIA

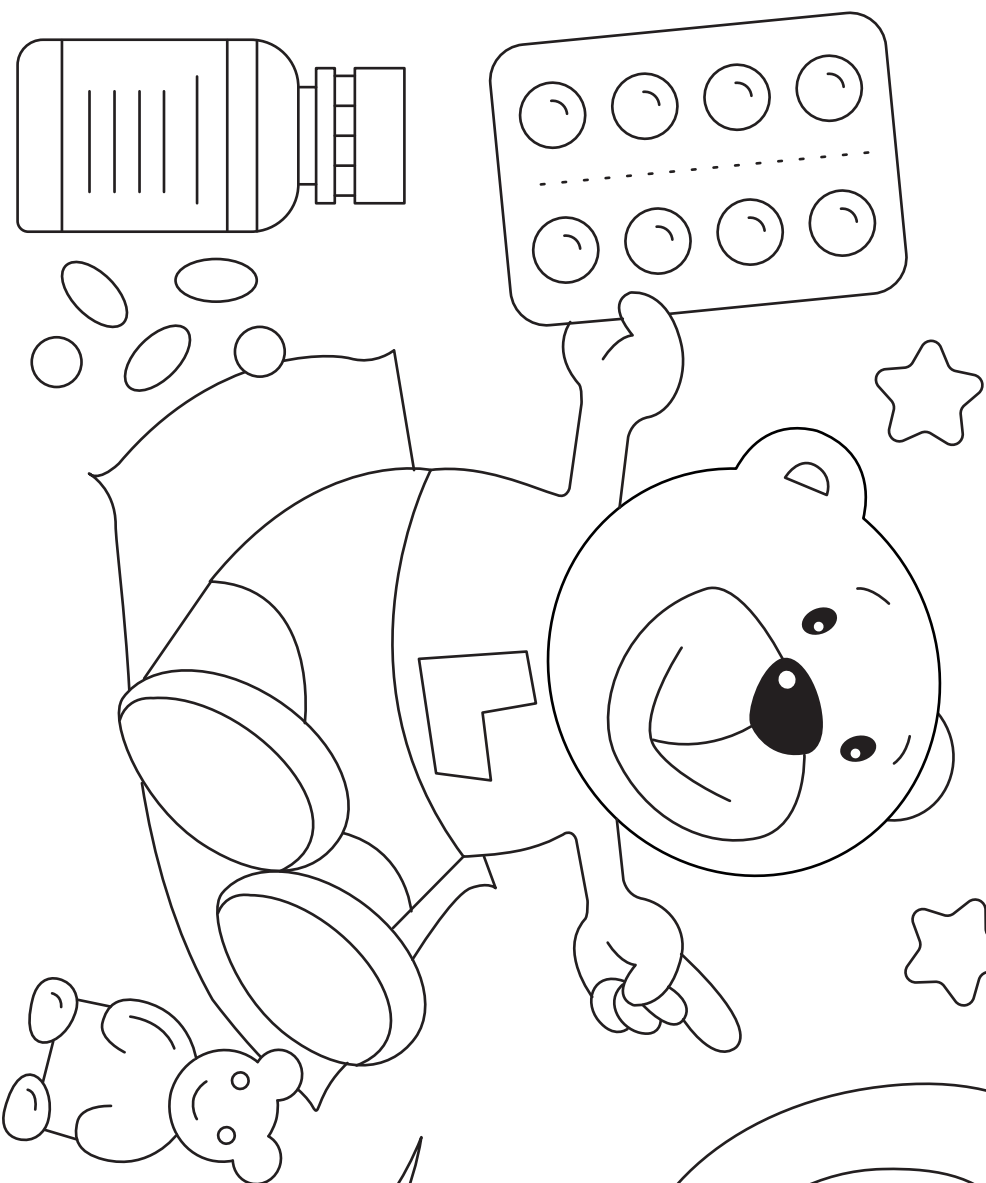

MIŚ LEKUŚ PRZYPOMINA:
LEKI POPIJAJ WODĄ!

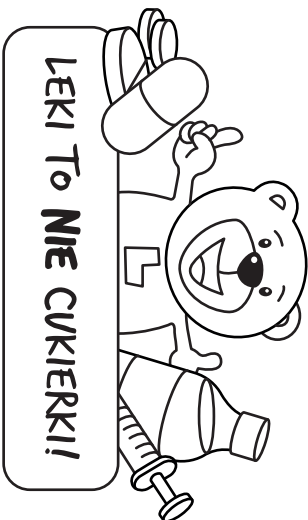

LEKUŚ ZACZĄŁ
KOMPLETOWAĆ
DOMOWĄ
APTECZKĘ,
POMÓŻ MU
DOKOŃCZYĆ
TO ZADANIE

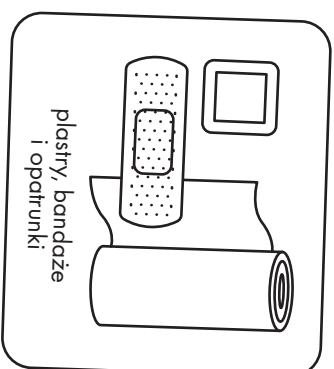
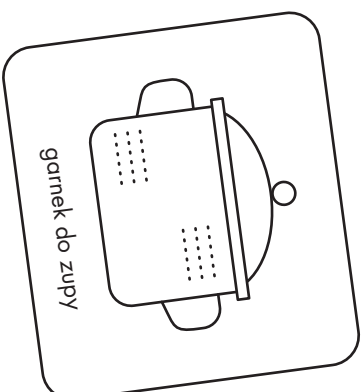
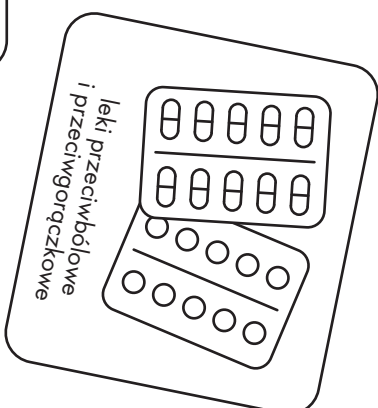
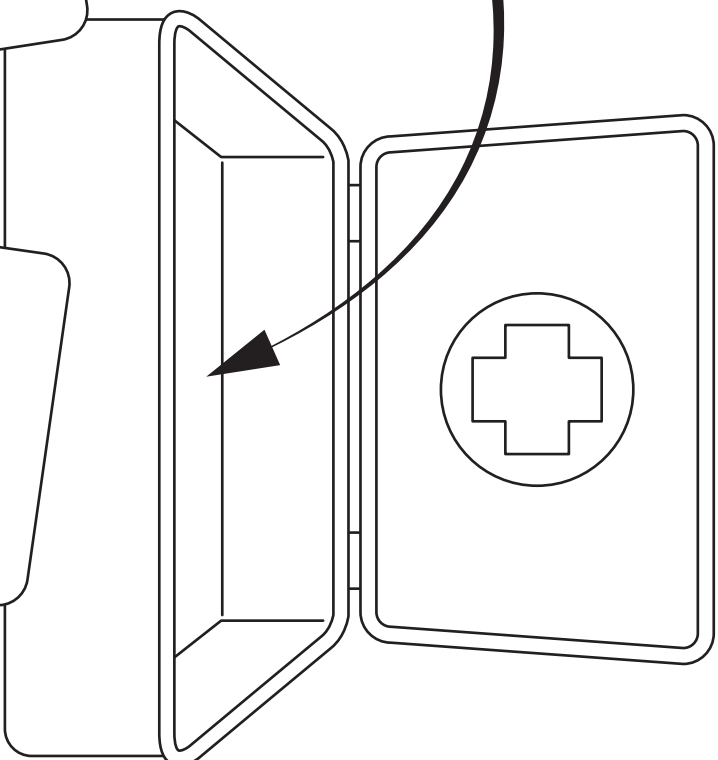
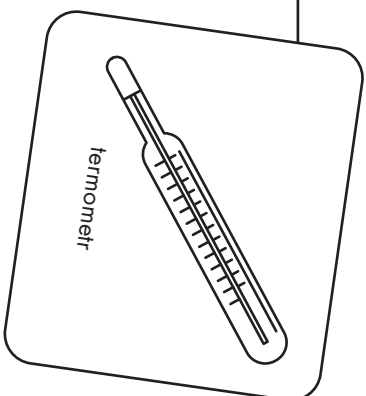
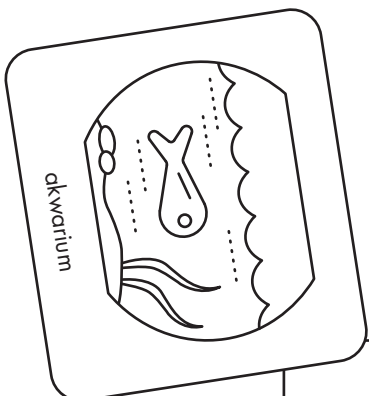
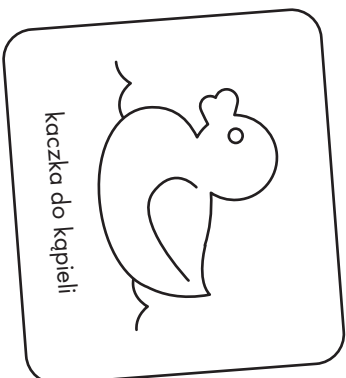
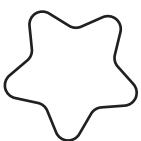
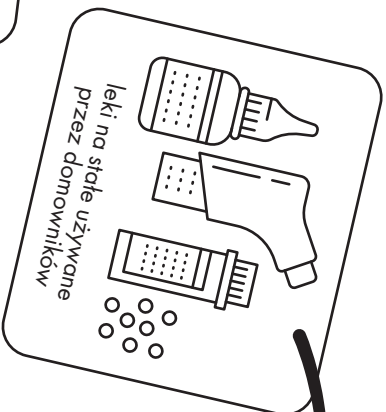
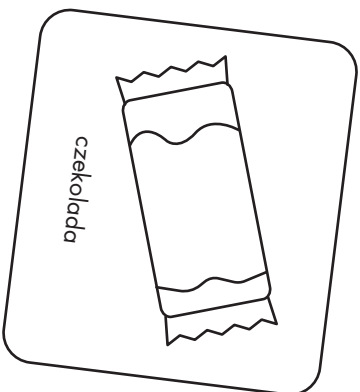

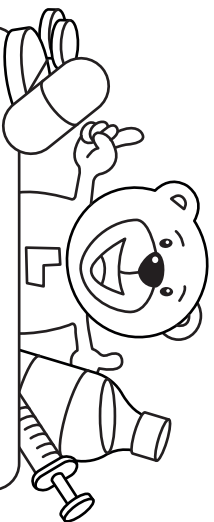

LEKI TO NIE CUKIERKI!

ZNAJDŹ 10 SZCZEGÓŁÓW,
KTÓRYMI RÓŻNIĄ SIĘ OBRAZKI

MIŚ LEKUŚ PRZYPOMINA:
LEKI KUPUJ W APTECEI!

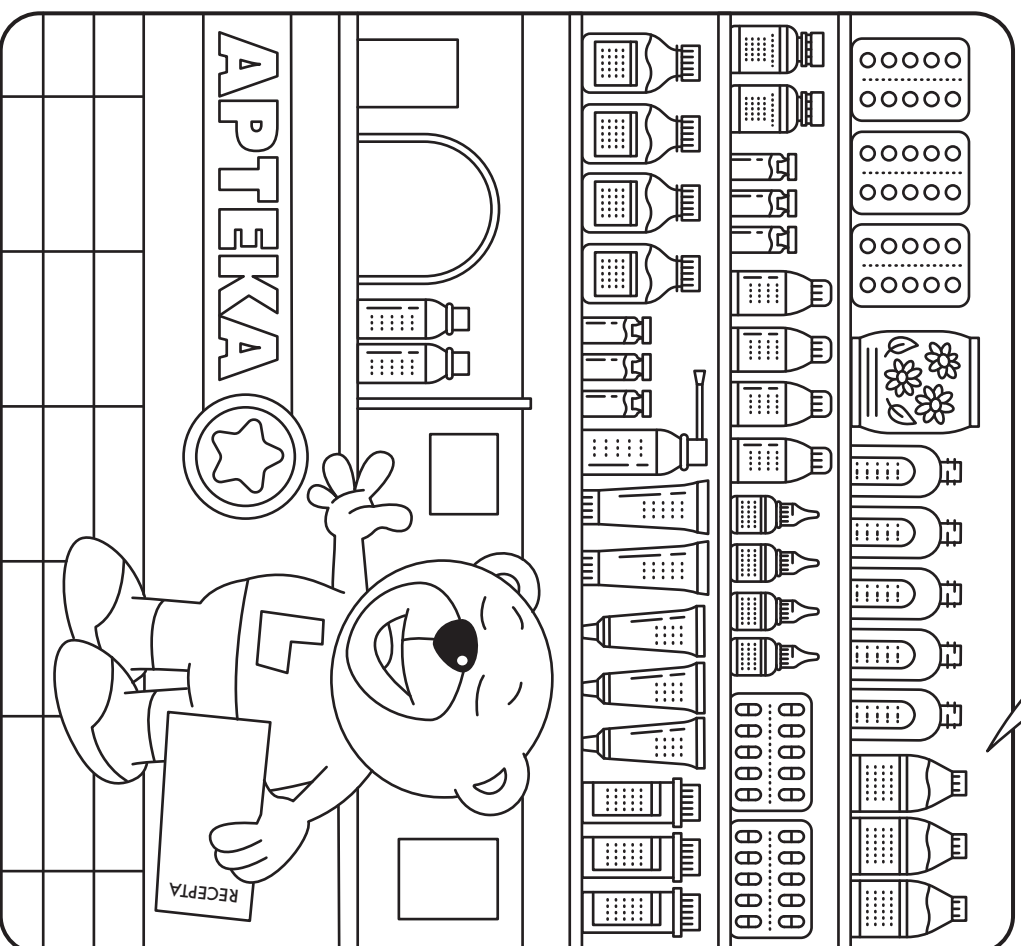
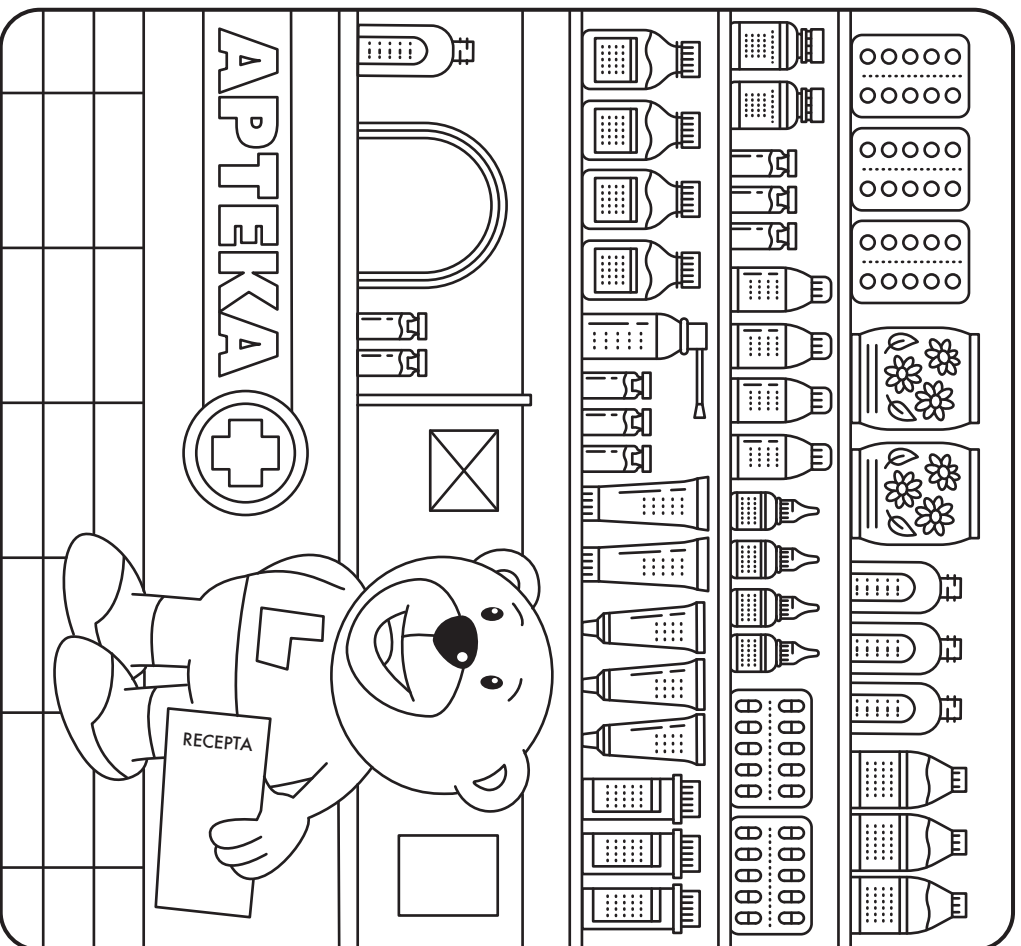

POMÓŻ MAMIE LEKUSIA ZNALEZĆ NAJLEPSZE MIEJSCE,
W KTÓRYM POWINNA PRZECHOWYWAĆ LEKI

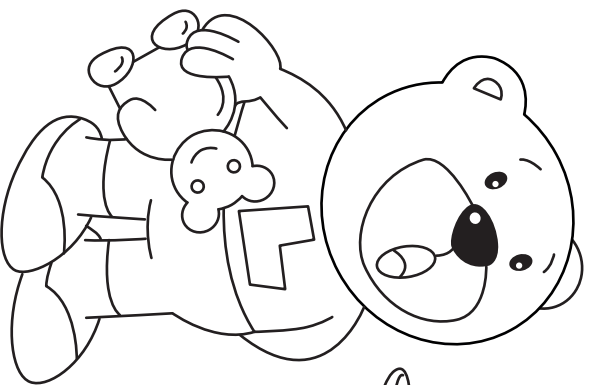
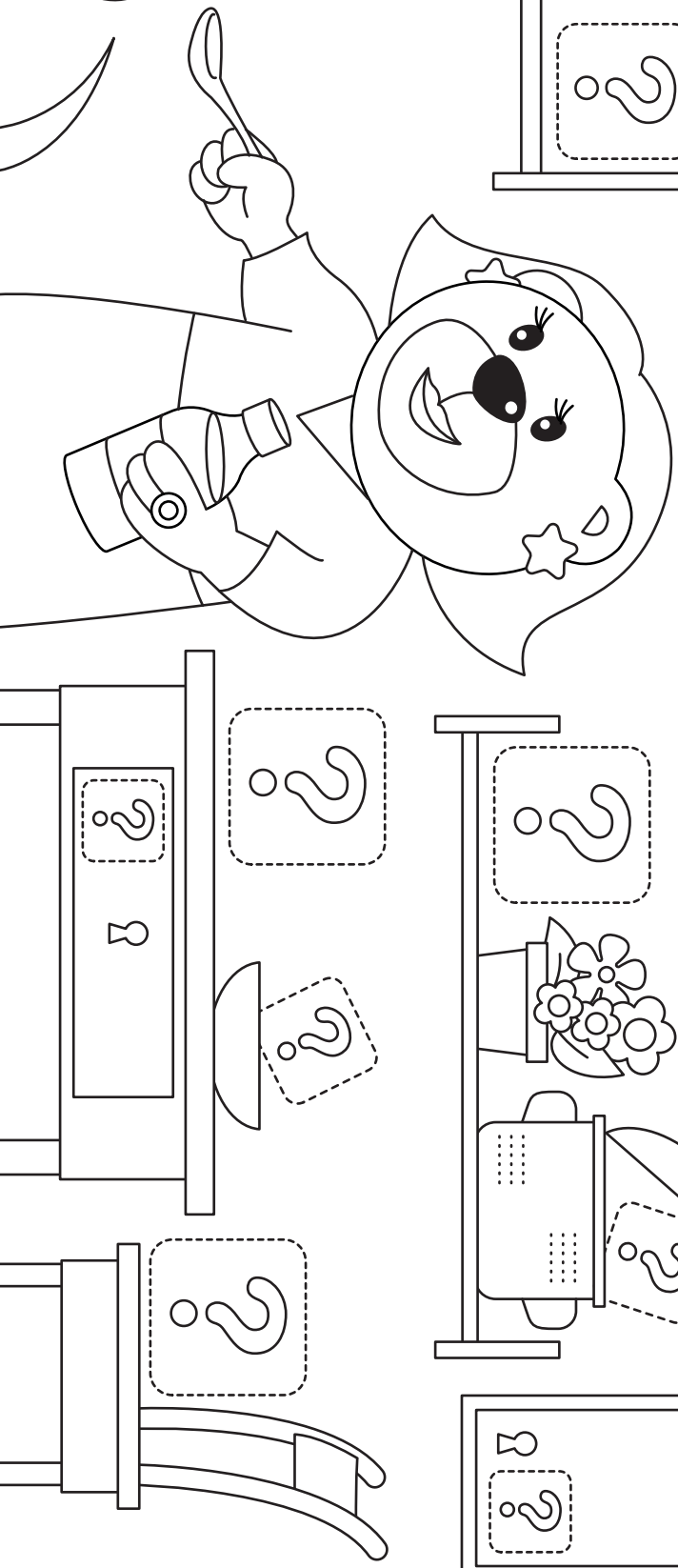
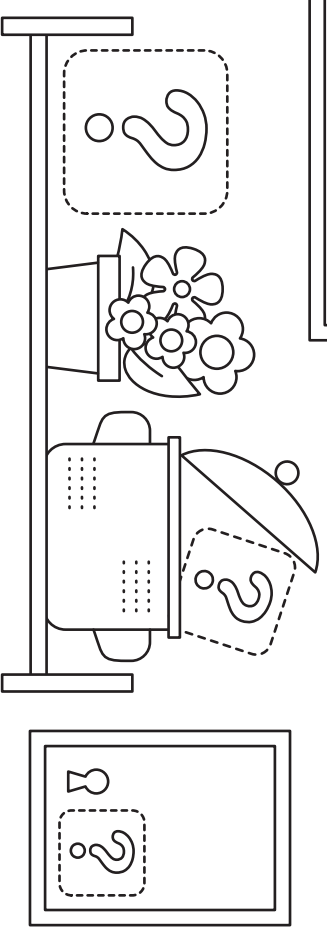
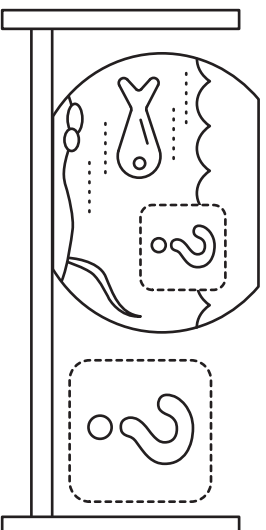
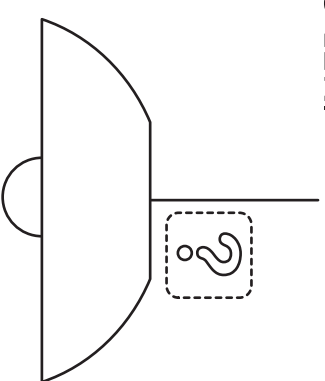
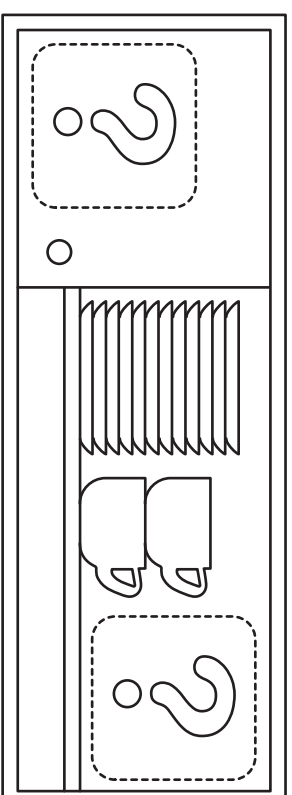
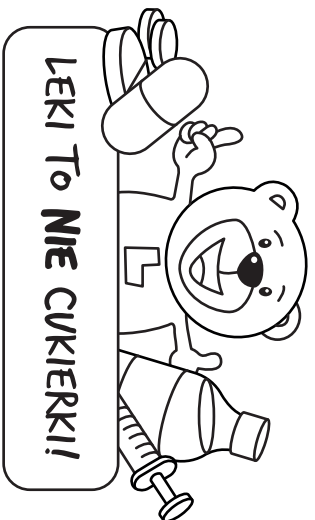

MIŚ LEKUŚ PRZYPOMINA: LEKI DZIECIOM PODAJE RODZICI!
TRZEBA JE PRZECHOWYWAĆ W MIEJSCU NIEDOSTĘPNYM DLA DZIECI

LEKI TO NIE CVKIERKI!

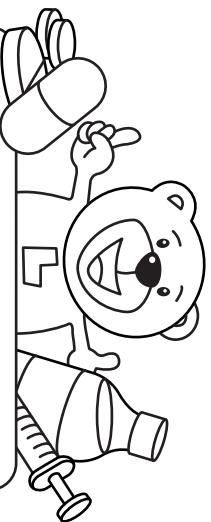

POMÓŻ TACIE LEKUSIA DOPASOWAĆ ULOTKI
DO OPAKOWAŃ LEKÓW

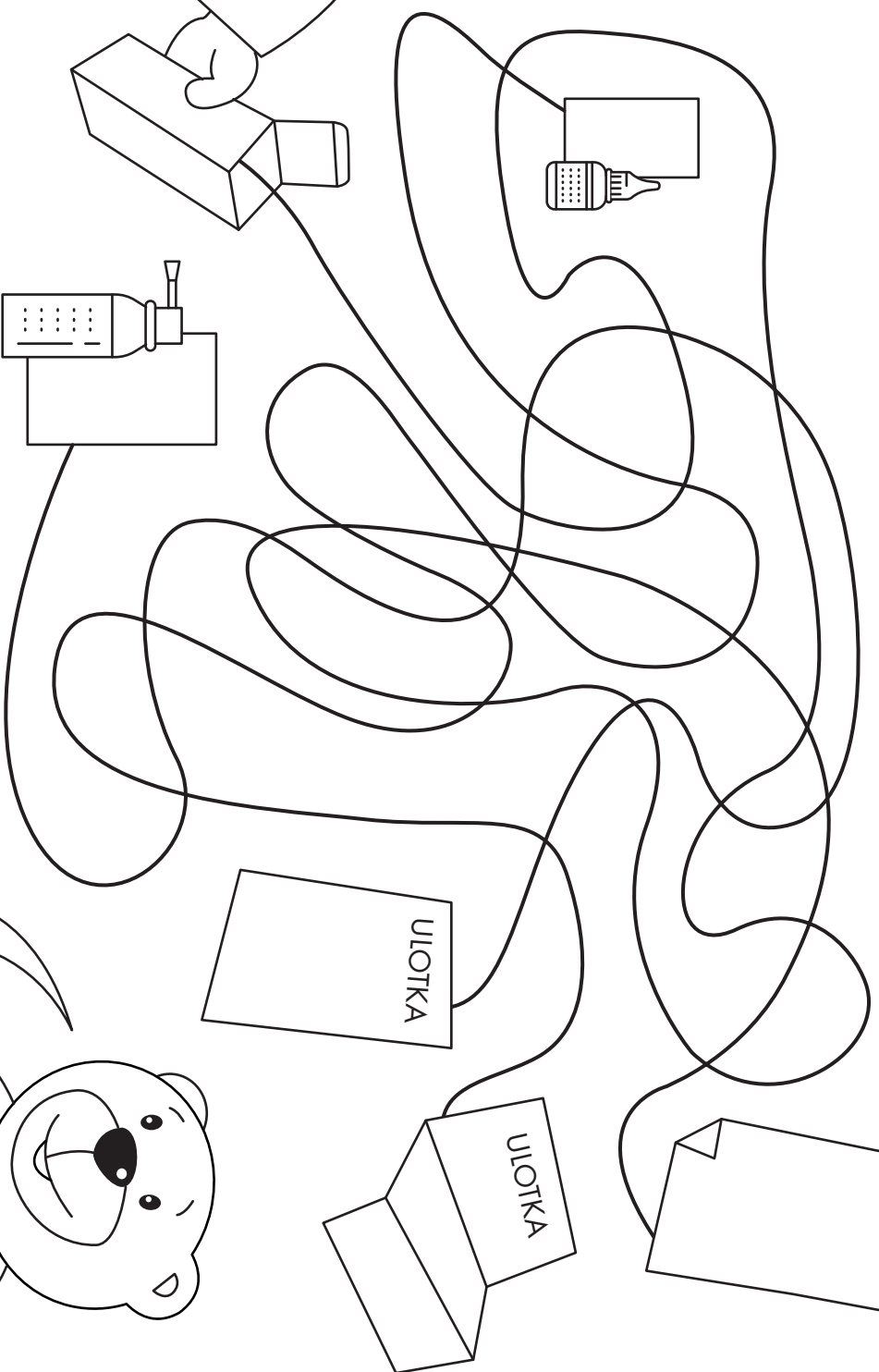
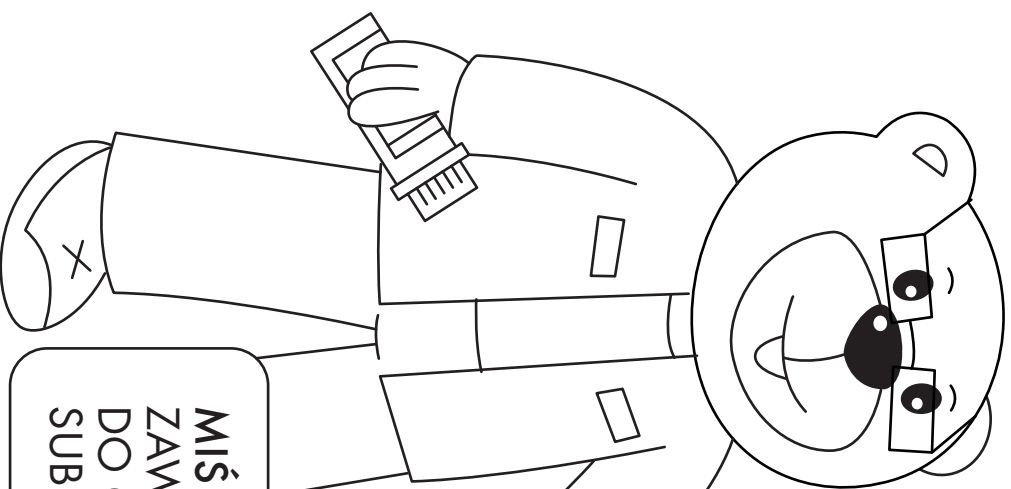

MIŚ LEKUŚ PRZYPOMINA: PRZED ZASTOSOWANIEM LEKU
ZAWSZE ZAPOZNAJ SIĘ Z TREŚCIĄ, ULOTKI DOŁĄCZONEJ
DO OPAKOWANIA, SPRAWDŹ NAZWĘ LEKU, NAZWĘ
SUBSTANCJI LECZNICZEJ, DAWKĘ LEKU I DATĘ WAŻNOŚCI!

